



# Série TD

## Tomadas 3,4,5 pólos + Terra e 8 pólos

### Características:

- Carcaças e bases de alumínio
- Inserto macho e fêmea em policarbonato
- Contatos macho e fêmea em latão prateado
- Inserto macho e fêmea polarizados
- Temperatura de trabalho -40°C +125°C
- Capacidade dos contatos:  
3,4 e 8 pólos 10A 250V  
5 pólos 16A 400V
- Grau de proteção: IP54
- Pinos de contatos por parafusos 3 e 4 pólos
- Pinos de contatos crimpados 5 e 8 pólos
- Fornecido com prensa cabo termoplástico



### Configurações e modelos

#### 3 Pólos + Terra



TD03M TD03F TD03D TD03J

Tomada Completa Código: TD03MDFJ



TD03M TD03F TD03G TD03J

Tomada Completa Código: TD03MGFJ



TD03M TD03F TD03D TD03Z

Tomada Completa Código: TD03MDFZ



TD03M TD03F TD03D TD03E

Tomada Completa Código: TD03MDFE

#### 4 Pólos + Terra



TD04M TD04F TD03D TD03J

Tomada Completa Código: TD04MDFJ



TD04M TD04F TD03G TD03J

Tomada Completa Código: TD04MGFJ



TD04M TD04F TD03D TD03Z

Tomada Completa Código: TD04MDFZ



TD04M TD04F TD03D TD03E

Tomada Completa Código: TD04MDFE

SUJEITO A ALTERAÇÃO SEM PRÉVIO AVISO



5 Pólos + Terra - pinos para crimpar



TD05M TD05F TD03D TD03J



TD05M TD05F TD03G TD03J



TD05M TD05F TD03D TD03Z



TD05M TD05F TD03D TD03E



Pinos para crimpar

- Capacidade: 16 A - 400V
- Bitola dos fios : 1,5 mm<sup>2</sup>

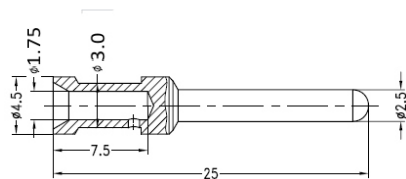

Pino Macho Código:CEM-1.5

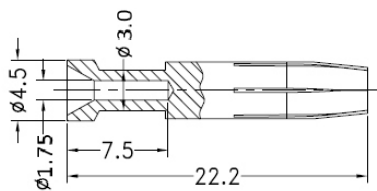

Pino Fêmea Código:CEF-1.5

8 Pólos - pinos para crimpar



TD08M TD08F TD03D TD03J



TD08M TD08F TD03G TD03J



TD08M TD08F TD03D TD03Z



TD08M TD08F TD03D TD03E



Pinos para crimpar

- Capacidade: 10 A - 250V
- Bitola dos fios: 1,0 mm<sup>2</sup>

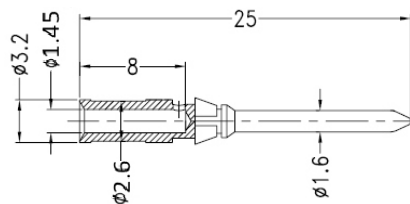

Pino Macho Código:CDM-1.0

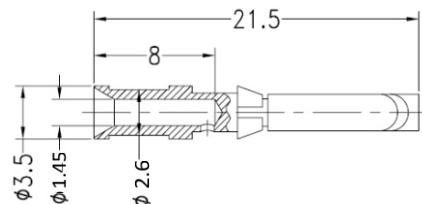









Pino Fêmea Código:CDF-1.0

SUJEITO A ALTERAÇÃO SEM PRÉVIO AVISO

# Insertos - Carcaças - Bases



## Insertos (Mioslos)

Macho	Fêmea	Macho	Fêmea	Macho	Fêmea	Macho	Fêmea
3 Pólos + Terra		4 Pólos + Terra		5 Pólos + Terra		8 Pólos	
TD03M	TD03F	TD04M	TD04F	TD05M	TD05F	TD08M	TD08F
							

## Carcaças

Saída Superior	Saída Lateral	Acoplamento
TD03D	TD03G	TD03E
		

## Bases

Baixa	Baixa 90°
TD03J	TD03Z
	

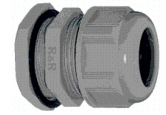

Fornecido com prensa Cabo Termoplástico

## Dimensões (mm)

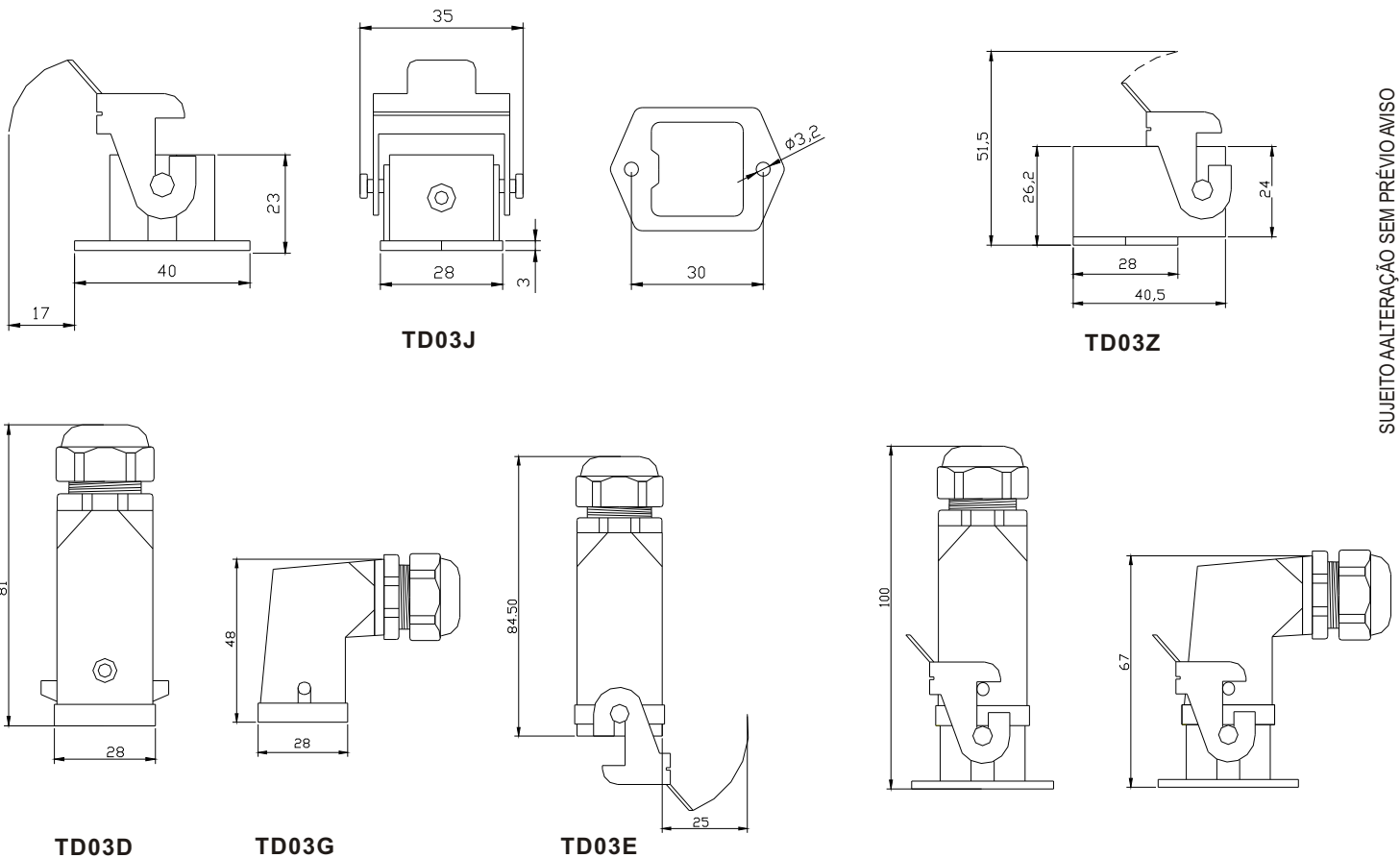

SUJEITO A ALTERAÇÃO SEM PRÉVIO AVISO